



TAA4100

FOUR CHANNEL CLASS-T DIGITAL AUDIO AMPLIFIER USING DIGITAL POWER PROCESSING (DPP™) TECHNOLOGY

Preliminary Information

Revision 0.97 – April 2005

GENERAL DESCRIPTION

The TAA4100 is a four-channel Audio Amplifier that uses Tripath's proprietary Digital Power Processing (DPP™) technology. Class-T amplifiers offer both the audio fidelity of Class-AB and the power efficiency of Class-D amplifiers. The TAA4100 has been designed specifically for automotive head unit applications and is configured with four bridged outputs operating on a single 10-26V supply.

APPLICATIONS

- Automotive Head Units
- Automotive Amplifiers
- DVD Receivers
- Multimedia Speaker Systems

BENEFITS

- 4-channel (400W) solution – with integrated FETs - in a single 32-pin SSIP package
- High fidelity, high efficiency Class-T
- Low external component count
- Single-supply operation



FEATURES

- Class-T architecture
- Four H-Bridge outputs
- "Audiophile" Sound Quality
- High Efficiency
- High Power @25.0V
 - 100W_{sat. sq. wave} @ 4Ω
 - 80W @ 4Ω, 10% THD+N
- "Audiophile" Quality Sound
 - 0.01% THD+N @ 40W 4Ω
 - 0.01% IHF-IM @ 1W 4Ω
- High Efficiency
 - 88% @ 100W 4Ω
- AM "Low EMI" mode
- Pop-Free startup and shutdown
- High Dynamic Range
- Mute and Stand-By function
- Automatic DC Offset Trim
- Clip Detection Output
- Protection Modes:
 - Output Short to VPP and Ground
 - Output Short across Load
 - Load Dump Protection
 - Over-/Under-Voltage Protection
 - Over-current Protection
 - Over-temperature Protection
 - Fortuitous Open Ground

Absolute Maximum Ratings (Note 1)

SYMBOL	PARAMETER	Value	UNITS
V _{PP}	Supply Voltage	33	V
V _{PPMAX}	Peak Supply Voltage ($t \leq 50\text{ms}$)	60	V
V _{PPAM}	Supply Voltage in AM Mode (Note 2)	18	V
V _{INRANGE}	Voltage Range for Input Section Pins (Note 3) Inputs (Pins 1-4, 6-9)	-0.5 to 5.5	V
T _{STORE}	Storage Temperature Range	-55 to +150	°C
I _R	Repetitive Peak Output Current	10	A
T _J	Maximum Junction Temperature	150	°C
P _D	Total Power Dissipation (T _{case} = 70°C)	80	W
ESD	ESD Susceptibility - Human Body Model (Note 4)	2k	V
ESD	ESD Susceptibility – Machine Model (Note 5)	200	V

Note 1: Absolute Maximum Ratings indicate limits beyond which damage to the device may occur.

See the table below for Operating Conditions.

Note 2: Supply voltage is limited in AM Mode due to additional power dissipation of output stage when operating in Class B mode. Please note that the TAA4100 is still fully protected from load dump transients in AM Mode.

Note 3: The input section pins (pins 1-9, 11,12) should not be connected to voltages over 5.5V with respect to pin 10 (AGND). Please note that pins 5, 11, and 12 are outputs and can be damaged if a voltage is forced externally.

Note 4: Human body model, 100pF discharged through a 1.5KΩ resistor.

Note 5: Machine model, 220pF – 240pF discharged through all pins.

Operating Conditions (Note 6)

SYMBOL	PARAMETER	MIN.	TYP.	MAX.	UNITS
V _{PP}	Supply Voltage (Note 6)	10	14.4	26	V
V _{PPAM}	Supply Voltage for AM Mode (Note 7)	10	14.4	16	V
T _A	Operating Free Air Temperature Range	-40	25	85	°C

Note 6: Recommended Operating Conditions indicate conditions for which the device is functional.

See Electrical Characteristics for guaranteed specific performance limits.

Note 7: Supply voltage is limited in AM Mode due to additional power dissipation of output stage when operating in Class B mode, as opposed to Switching Mode.

Thermal Characteristics

SYMBOL	PARAMETER	Value	UNITS
θ _{JC}	Junction-to-case Thermal Resistance	1.0°	C/W
θ _{JA}	Junction-to-ambient Thermal Resistance (still air)	20°	C/W

Electrical Characteristics (Note 8)

$T_A = 25^\circ\text{C}$. Unless otherwise noted, the supply voltage is $V_{PP} = 14.4\text{V}$. See Application/Test Circuit.

SYMBOL	PARAMETER	Conditions	MIN.	TYP.	MAX.	UNITS
R_{IN}	Input Impedance		43	50	57	$k\Omega$
I_Q	Quiescent Current	No load		220	250	mA
I_{STBY}	Stand-By Current	$V_{SLEEPB} < 0.15\text{V}$		100	200	μA
V_{IL}	Stand-By On Threshold Voltage	SLEEPB Low (amp off)			0.5	V
V_{IH}	Stand-By Off Threshold Voltage	SLEEPB High (amp on)	2.3			V
V_{IL}	Mute-On Threshold Voltage	MUTE pin Low			1	V
V_{IH}	Mute-Off Threshold Voltage	MUTE pin High	2.3			V
VOS	Output Offset Voltage	(Mute Off) DC trim active		± 3	± 25	mV
V_{OH}	Fault Reporting Logic Output High Voltage	Open Drain Output	3.5			V
V_{OL}	Fault Reporting Logic Output Low Voltage	$R_{FAULT} = 51K\Omega$			1	V
V_{IH}	AM Mode On Threshold Voltage	AM pin High	2.3			V
V_{IL}	AM Mode Off Threshold Voltage	AM pin Low			1	V
I_{AM}	AM Mode Pin Input Current				1	μA

Note 8: Minimum and maximum limits are guaranteed but may not be 100% tested.

Performance Characteristics (Note 8)

$T_A = 25^\circ\text{C}$. Unless otherwise noted, the supply voltage is $V_{PP} = 14.4\text{V}$, $R_L = 4\Omega$. Measurement Bandwidth = 20kHz. See Application/Test Circuit.

SYMBOL	PARAMETER	CONDITIONS	MIN.	TYP.	MAX.	UNITS
P_{OUT}	Output Power (Continuous power/ channel)	$V_{PP}=25\text{V}$ sat. sq. wave $V_{PP}=25\text{V}$ THD+N=10% $V_{PP}=25\text{V}$ THD+N=1% $V_{PP}=14.4\text{V}$ sat. sq. wave, $R_L = 2\Omega$ $V_{PP}=14.4\text{V}$ THD+N=10%, $R_L = 2\Omega$ $V_{PP}=14.4\text{V}$ THD+N=1%, $R_L = 2\Omega$ $V_{PP}=14.4\text{V}$ sat. sq. wave $V_{PP}=14.4\text{V}$ THD+N=10% $V_{PP}=14.4\text{V}$ THD+N=1%		100 80 65 62 45 36 40 28 22		W W W W W W W W W
A_V	Voltage Gain V_{OUT}/V_{IN} , $R_{IN} = 0\Omega$		28.7	29.7	30.7	dB
THD + N	Total Harmonic Distortion Plus Noise	$P_{OUT} = 10\text{W}/\text{Channel}$, $R_L = 4\Omega$ BW = 22Hz-20kHz(AES17)		0.01		%
IHF-IM	IHF Intermodulation Distortion	19kHz, 20kHz, 1:1 (IHF) $P_{OUT} = 1\text{W}/\text{Channel}$		0.01		%
SNR	Signal-to-Noise Ratio	A-Weighted, $P_{OUT} = 100\text{W}/\text{Channel}$, $V_{PP}=25\text{V}$		97		dB
PSRR	Power Supply Rejection Ratio	$V_{PP}=14.4\text{V}$, Ripple=200mV, $f = 1\text{kHz}$		60		dB
η	Power Efficiency	$V_s=25.0\text{V}$, 4 x 100W sat sq wave		88		%
CS	Channel Separation	$P_o=1\text{W}$, $f = 1\text{kHz}$ $P_o=1\text{W}$, $f = 10\text{kHz}$		80 65		dB dB
e_{nOUT}	Output Noise Voltage	A-Weighted		200		μV

AM Mode (Note 9)

$T_A = 25^\circ\text{C}$. Unless otherwise noted, the supply voltage is $V_{PP} = 14.4\text{V}$, $R_L = 4\Omega$. Measurement Bandwidth = 20kHz. See Application/Test Circuit.

SYMBOL	PARAMETER	CONDITIONS	MIN.	TYP.	MAX.	UNITS
I_{OCD}	Over-current detect		5.5			A
THD+N	Total Harmonic Dist plus Noise	$P_o=0.5\text{-}5\text{W}$ per channel		0.04		%
SNR	Signal to Noise ratio	A-Weighted, $P_o=15\text{W}$		92.5		dB
P_{out}	Output Power (Note 7)	$V_{PP}=16\text{V}$, THD+N=10% $V_{PP}=14.4\text{V}$, THD+N=10%		20 16		W W
CS	Channel Separation	$P_o=1\text{W}$, $f=1\text{kHz}$		80		dB
e_n	Output Noise Voltage	A-Weighted		185		μV

Note 9: The TAA4100 heat sinking in AM Mode must be increased (as compared to Class T mode) to sustain the typical output numbers. This is due to the lower efficiency of Class B output stage operation. Please note that the AM Mode operating supply range, due to this increased power dissipation, is 10V-16V.

Protection Circuits (Note 8)

$T_A = 25^\circ\text{C}$. Unless otherwise noted, the supply voltage is $V_{PP} = 14.4\text{V}$.

SYMBOL	PARAMETER	CONDITIONS	MIN.	TYP.	MAX.	UNITS
OV_{ON}	Over-voltage Threshold	Over-voltage turn on (amp muted)	27.0	30	32.5	V
OV_{OFF}	Over-voltage Reset	Over-voltage turn off (mute off)	26.0	28.0		V
UV_{OFF}	Under-voltage Reset	Under-voltage turn off (mute off)		9.5	10.0	V
UV_{ON}	Under-voltage Threshold	Under-voltage turn on (amp muted)	7.8	8.1	8.6	V
OT_{ON}	Over-Temperature Threshold	Over-temperature turn on (amp muted)	150	160	170	$^\circ\text{C}$
OT_{OFF}	Over-Temperature Reset	Over-temperature turn off (mute off)	120	130	140	$^\circ\text{C}$
I_{OC}	Over-Current Detect	1kHz ramp, $V_{PP} = 25\text{V}$	8.0	9.5		A
VP_{MAX}	Load Dump Voltage Withstand	Test conditions, $t_r > 2.5\text{ms}$, $t_{pulse} < 50\text{ms}$	60			V

TAA4100 Pinout

32-pin SSIP Package
(Top View)

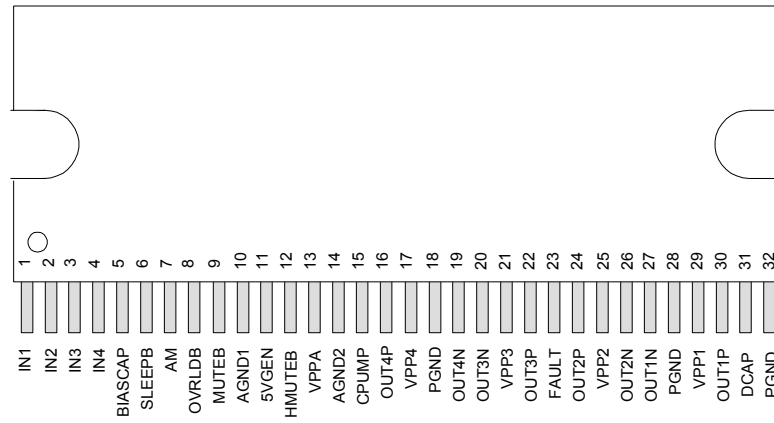

Note: The heat slug of the TAA4100 is connected to PGND.

Pin Description

PIN	NAME/FUNCTION	TYPE	DESCRIPTION
1	IN1	INPUT	Channel 1 Input
2	IN2	INPUT	Channel 2 Input
3	IN3	INPUT	Channel 3 Input
4	IN4	INPUT	Channel 4 Input
5	BIASCAP		Internal reference bypass capacitor connection
6	SLEEPB	INPUT (L)	Logic input, ACTIVE LOW. Setting SLEEP to low puts the TAA4100 in sleep mode. This pin must be driven high via an external power supply or microcontroller for the TAA4100 to begin operation. Input range is 0 to 5V with 3.3V compliant inputs.
7	AM	INPUT (L)	Logic input, ACTIVE HIGH. Enables Analog Mode operation. Typically driven by an external power supply of microcontroller. Input range is 0 to 5V with 3.3V compliant inputs.
8	OVRLDB	OUTPUT (L)	Logic output, ACTIVE LOW. OVRLDB low indicates the input has overloaded the amplifier
9	MUTEB	INPUT (L)	Logic Input, ACTIVE LOW. Setting MUTE to low puts the device in mute mode. Typically driven by external power supply or microcontroller. Input range is 0 to 5V with 3.3V compliant inputs.
10	AGND1	GND	Analog ground
11	5VGEN		On chip 5V regulator bypass capacitor connection
12	HMUTEB	OUTPUT (L)	Logic output, ACTIVE LOW. HMUTEB low indicates TAA4100 is in mute mode
13	VPPA	POWER	Positive power supply voltage connection
14	AGND2	GND	Analog ground
15	CPUMP	OUTPUT	Charge pump output capacitor
16	OUT4P	OUTPUT	Positive Output Channel 4
17	VPP4	POWER	Positive Supply Voltage Channel 4
18	PGND	GND	Power Ground
19	OUT4N	OUTPUT	Negative Output Channel 4
20	OUT3N	OUTPUT	Negative Output Channel 3
21	VPP3	POWER	Positive Supply Voltage Channel 3
22	OUT3P	OUTPUT	Positive Output Channel 3
23	FAULT	OUTPUT (L)	Open Drain Logic Output, ACTIVE HIGH. FAULT high indicates fault condition.
24	OUT2P	OUTPUT	Positive Output Channel 2
25	VPP2	POWER	Positive Supply Voltage Channel 2
26	OUT2N	OUTPUT	Negative Output Channel 2
27	OUT1N	OUTPUT	Negative Output Channel 1
28	PGND	GND	Power Ground
29	VPP1	POWER	Positive Supply Voltage Channel 1
30	OUT1P	OUTPUT	Positive Output Channel 1
31	DCAP	OUTPUT	External Charge Pump Circuit Output. DCAP is a free running 400kHz square wave between VDDA (pin 13) and AGND (pin 14) with a 14.4Vpp nominal amplitude.
32	PGND	GND	Power Ground

TAA4100 Functional Block Diagram

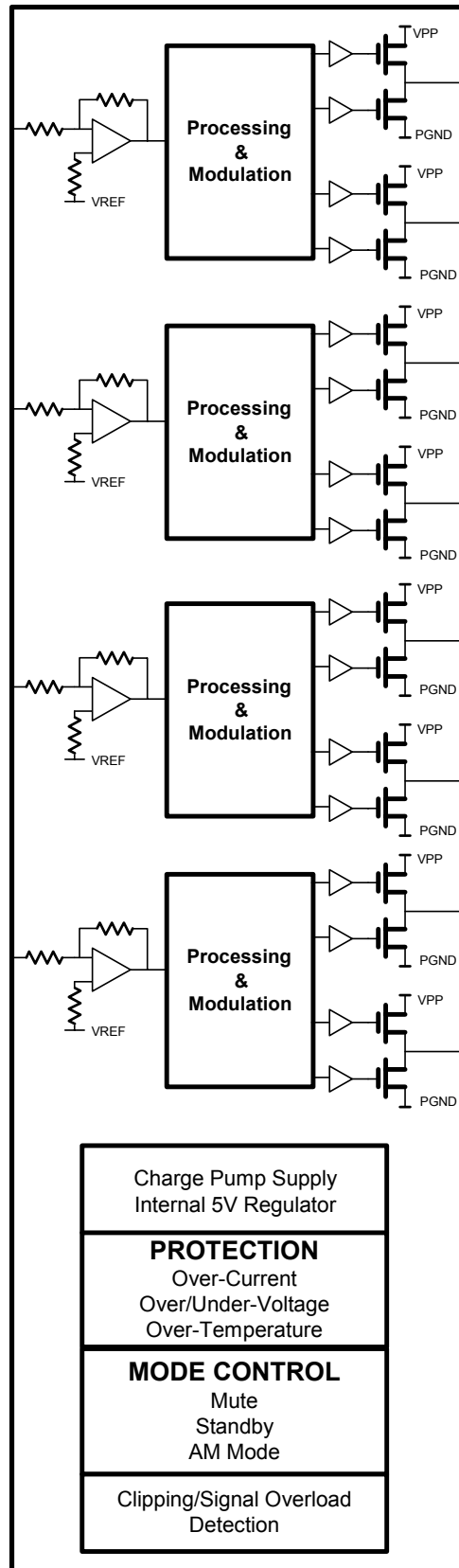

External Components Description (Refer to the Application/Test Circuit)

Components	Description
C _I	AC input coupling capacitor which, in conjunction with R _{IN} , forms a highpass filter at $f_c = 1/(2\pi R_{IN} C_I)$ where R _{IN} is typically 50kΩ.
C _S	Supply decoupling for the power supply pins. For optimum performance, these components should be located close to the TAA4100 and returned to their respective “ground” as shown in the Application/Test Circuit.
C _{BR}	Supply decoupling for the high current full-bridge supply pins. These components must be located as close to the power supply pins as possible to minimize output ringing which causes power supply overshoot. By reducing overshoot, these capacitors maximize the TAA4100 reliability. These capacitors should have good high frequency performance including low ESR and low ESL.
C _{CP}	Supply decoupling for the charge pump (high side gate drive supply) circuitry. These components must be located as close to the TAA4100 as possible.
D _O	Output diode, which is used to minimize output overshoots/undershoots on the output nodes. These devices clamp the output to the low impedance node formed by the close connection of C _{BR} . Note the connection shown in the Application/Test Circuit. The “high side” diode protects the bottom side device from excessive BV _{DSS} due to overshoots on the output node. The “bottom side” diode protects the top side device from excessive BV _{DSS} due to undershoots on the output node. This device must be an ultra fast rectifier capable of sustaining the entire supply range and high peak currents.
C _Z	Zobel capacitor, which in conjunction with R _Z , terminates the output filter at high frequencies. Use a high quality film capacitor capable of sustaining the ripple current caused by the switching outputs.
R _Z	Zobel resistor, which in conjunction with C _Z , terminates the output filter at high frequencies. The combination of R _Z and C _Z minimizes peaking of the output filter under both no load conditions or with real world loads, including loudspeakers, which usually exhibit a rising impedance with increasing frequency. Depending on the program material, the power rating of R _Z may need to be adjusted. If the system requires full power operation at 20kHz then the power rating for R _Z will likely need to be increased.
L _O	Output inductor, which in conjunction with C _O and C _{DO} , demodulates (filters) the switching waveform into an audio signal. Forms a second order filter with a cutoff frequency of $f_c = 1/(2\pi \sqrt{L_O C_{TOT}})$ and a quality factor of $Q = R_L C_{TOT} / 2\sqrt{L_O C_{TOT}}$ where C _{TOT} = C _O 2 * C _{DO} .
C _O	Output capacitor, which, in conjunction with L _O , demodulates (filters) the switching waveform into an audio signal. Use a high quality film capacitor capable of sustaining the ripple current caused by the switching outputs.
C _{DO}	Differential Output Capacitor. Differential noise decoupling for reduction of conducted emissions. Must be located near chassis exit point for maximum effectiveness.
R _{FAULT}	Pull-up resistor for the open drain FAULT pin output. Recommended resistor value is 51kΩ.
D _{CP}	Charge pump diodes. Used to generate floating supply for driving high side circuitry. Small signal diodes such as 1N4148 are recommended for these components.

Typical Performance

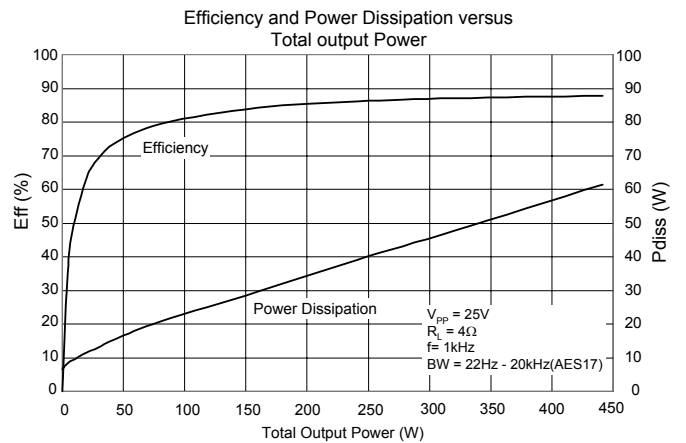
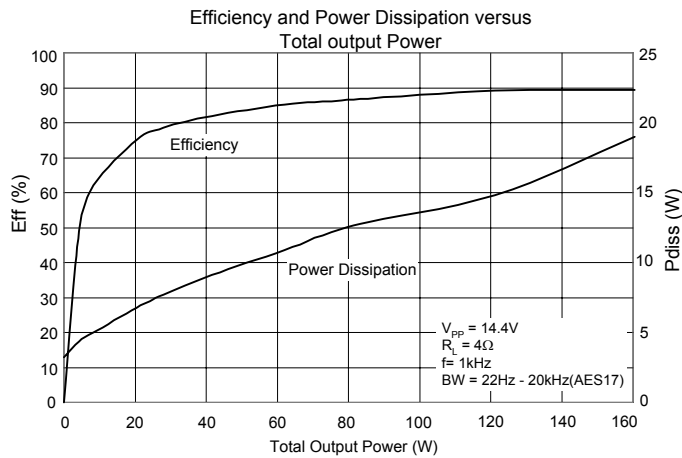
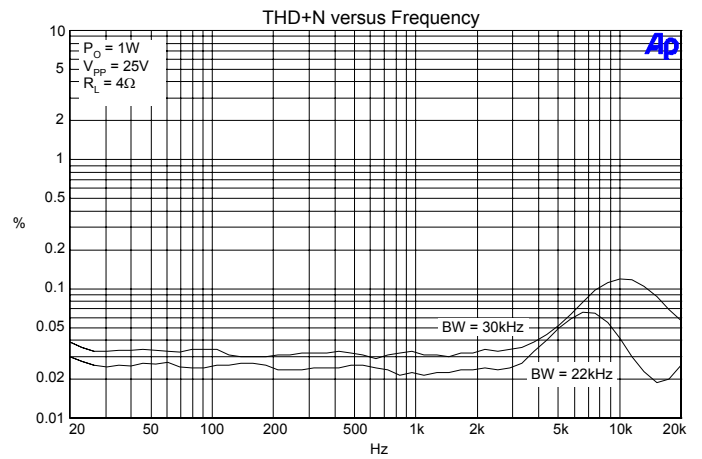
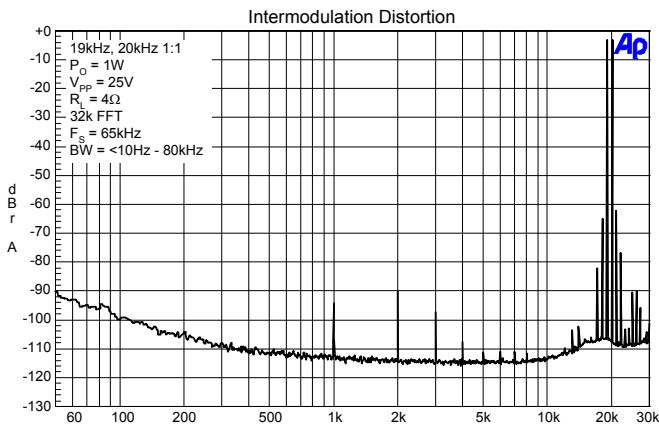
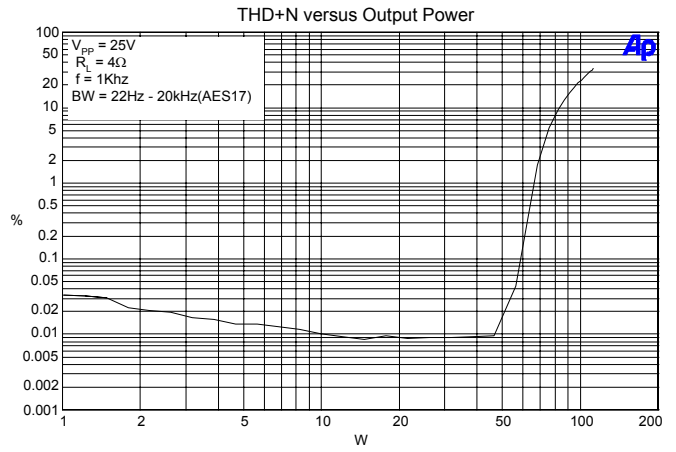
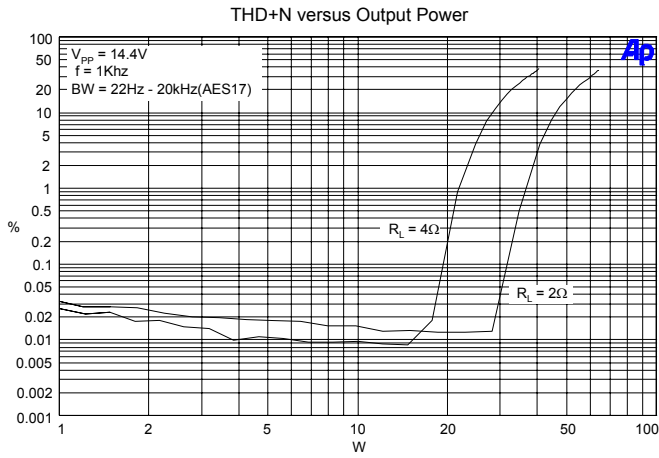

Typical Performance (continued)

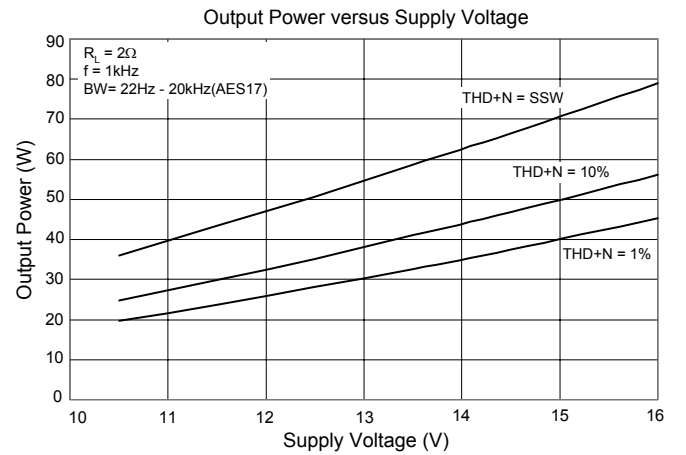
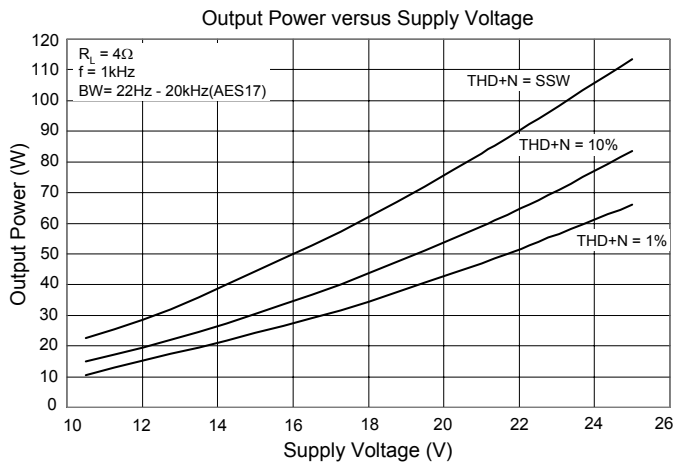
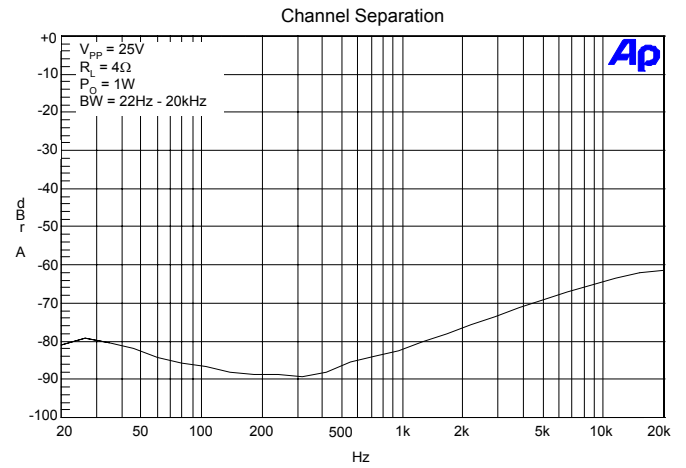
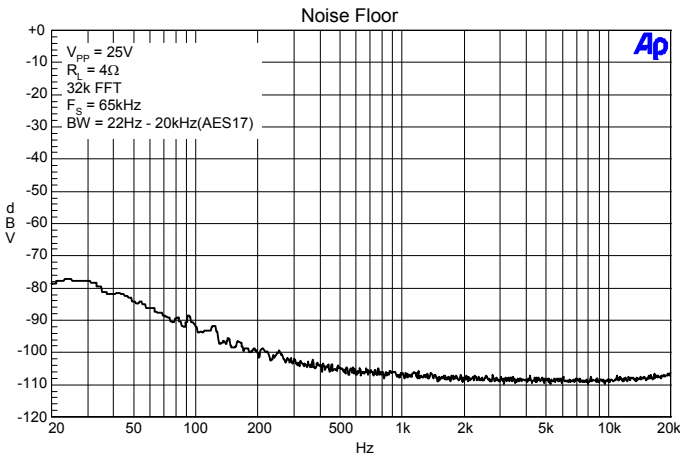
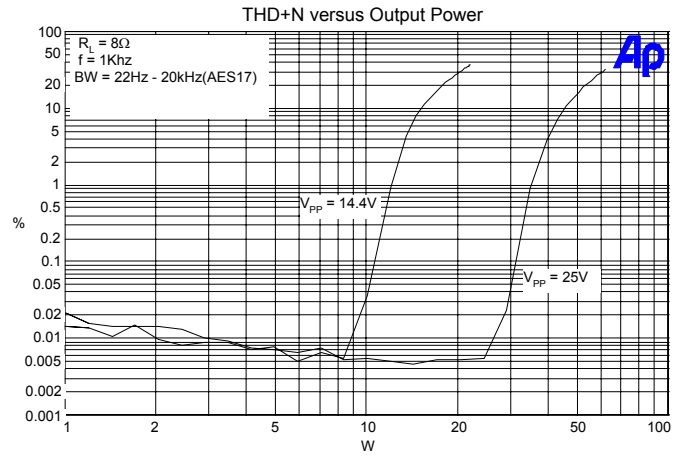
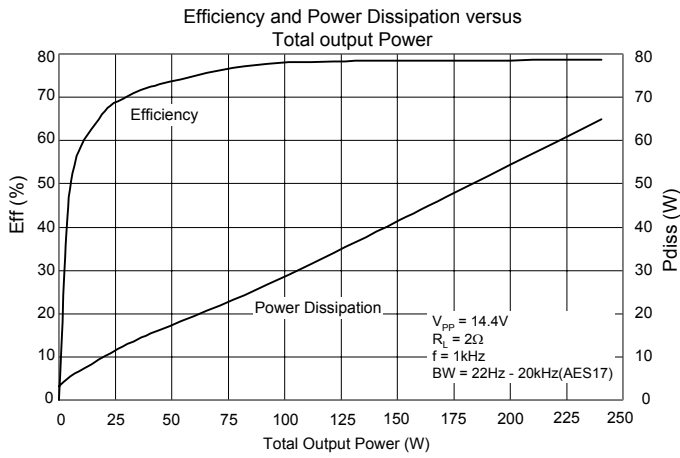

Typical Performance AM Mode

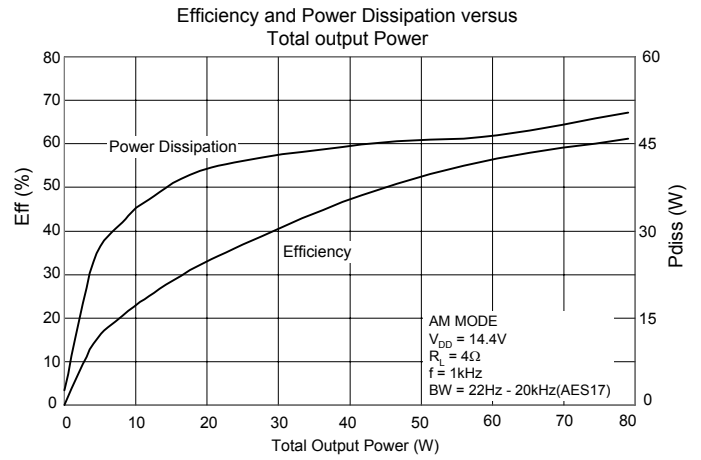
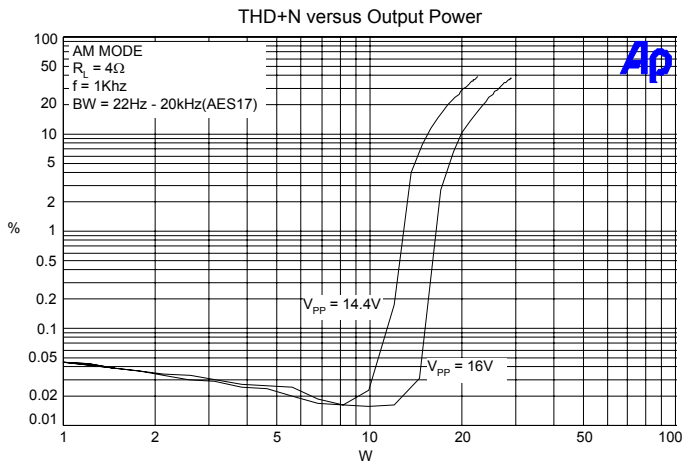

Application Information

GENERAL DESCRIPTION

The TAA4100 is a 4-channel BTL (Bridge Tied Load) output audio amplifier that operates on a single supply voltage ranging from 10-26V. The device is targeted specifically to meet the demands of OEM and aftermarket automobile in-dash head units. With a single supply voltage of 25V, the device delivers four 100 Watt (saturated square wave) channels into 4 ohm. Since the TAA4100 is a switching amplifier, the average dissipation at low to medium output power is far superior to best in class AB amplifiers specifically designed for in-dash head units.

TAA4100 BASIC AMPLIFIER OPERATION

The TAA4100 has three major operational blocks: the signal processor, the MOSFET driver and the power MOSFETs. The signal processor is a 5V CMOS block that amplifies the audio input signal and converts the signal to a high frequency switching pattern. This switching pattern is spread spectrum in nature and has a typical idle switching frequency of about 650kHz.

The MOSFET driver level shifts the processor's 5V switching pattern to the VPP power supply voltage and drives the power MOSFETs. The MOSFETs are N-channel devices configured as a full bridge to supply audio power to the load. The outputs of the power MOSFETs must be low pass filtered to remove the high frequency switching pattern leaving only the amplified audio signal.

CIRCUIT BOARD LAYOUT

The TAA4100 is a power (high current) amplifier that operates at relatively high switching frequencies. Therefore, amplifier outputs switch between the supply voltage and ground at high speeds while driving high currents. This high-frequency digital signal is passed through an LC low-pass filter to recover the amplified audio signal. Since the amplifier must drive the inductive LC output filter and speaker loads, the amplifier outputs can be pulled above the supply voltage and below ground by the energy in the output inductance. To avoid subjecting the TAA4100 to potentially damaging voltage stress, it is critical to have a good printed circuit board layout. It is recommended that Tripath's layout and application circuit be used for all applications and only be deviated from after careful analysis of the effects of any changes. Please refer to the TAA4100 evaluation board document, EB-TAA4100, available on the Tripath website, at www.tripath.com.

The following components are important to place near either their associated TAA4100 pins. The recommendations are ranked in order of layout importance, either for proper device operation or performance considerations.

- The capacitors, C_{BR} , provide high frequency bypassing of the amplifier power supplies and will serve to reduce spikes and modulation of the power supply rails. Please note that bypassing requires a combination of capacitors for adequate stabilization.
- The output diodes, D_O , are used to minimize overshoots/undershoots on the output node. Improper routing of these diodes will render them useless due to PCB trace inductance. Thus, these components must be located very close to the output pins with the "other side of the diode" routed directly to the appropriate VPP or PGND pin.
- The capacitors, C_S , provide high frequency bypassing of the amplifier power supplies. Please note that bypassing requires a combination of capacitors for adequate stabilization.

TAA4100 GROUNDING

Proper grounding techniques are required to maximize TAA4100 functionality and performance. Parametric parameters such as THD+N, Noise Floor and Crosstalk can be adversely affected if proper

grounding techniques are not implemented on the PCB layout. The following discussion highlights some recommendations about grounding both with respect to the TAA4100 as well as general “audio system” design rules.

The TAA4100 is divided into two sections: the input section, which spans pins 1-11 and the output (high voltage) section, which spans pins 12 through pin 32. On the TAA4100 evaluation board, the ground is also divided into distinct sections, one for the input and one for the output. To minimize ground loops and keep the audio noise floor as low as possible, the input and output ground should be externally connected at a single point as close to the TAA4100 as possible. Additionally, any external input circuitry such as preamps, or active filters, should be referenced to pin 10.

INPUT STAGE DESIGN

The TAA4100 input stage is configured as an inverting amplifier that allows the system designer flexibility in setting the low frequency response. The gain is internally set at approximately 30dB with a typical input impedance of 50kohm.

Please note that the input stage of the TAA4100 runs off of an internally regulated 5V supply. Thus, the input signal should not exceed 5Vpp (absolute maximum is 6Vpp). Due to the gain structure of the TAA4100, it will likely be necessary to drive the input stage with more than 5Vpp to achieve the saturated sine wave output numbers shown in the typical characteristics. If this requirement is needed for a specific application, then the input pins (pins 1-4) should be schottky diode clamped between AGND (pin 10) and 5VGEN (pin 11). Suitable schottky diode arrays are available in small package footprints from multiple semiconductor companies.

INPUT CAPACITOR SELECTION

C_I and R_{IN} (typically 50k Ω) determine the input low-frequency pole. Typically this pole is set at 10Hz. C_I is calculated according to:

$$C_I = 1 / (2\pi \times F_P \times R_I)$$

where:

$$R_I = 50k\Omega$$

$$F_P = \text{Input low frequency pole (typically less than 10Hz)}$$

AUTOMATIC OUTPUT OFFSET VOLTAGE CORRECTION

The TAA4100 contains an automatic DC calibration routine that reduces the output offset voltage to a maximum of 25mV when the device is active (mute off). Please note that the DC calibration is done on the transition of MUTEB from low to high. The entire calibration sequence takes approximately 6mS after the MUTEB pin is pulled high.

POWER SUPPLY REQUIREMENTS

The device is configured to operate from a single supply voltage of 10-26V. This allows the device to operate from an automobile battery under various conditions including: battery voltage with the engine off, alternator voltage with engine running and boosted voltage operation up to 26V using a DC-DC converter or voltage booster. The sleep pin must be driven from a microcontroller or external 3.3V or 5.0V power supply.

AM MODE

The TAA4100 is typically configured as a high power, high efficiency, four channel switching amplifier. The TAA4100 also has an additional amplifier mode named “AM Mode.” By pulling the AM pin to a logic high level, the TAA4100 is configured as a Class B amplifier as opposed to the normal, Class-T amplifier.

AM mode significantly reduces EMI generation since the output amplifiers are now operated in linear mode. Operating in Class B mode also reduces the TAA4100 efficiency especially at low to medium output powers. Due to this increased power dissipation, it is recommended that the AM mode is used for applications such as AM radio playback where the average output level is minimal and a switching amplifier would most effect radio reception. The operating supply range is also limited to 10V-16V due to the increased power dissipation.

A DC to DC converter that is used to step up the battery voltage for Class T operation (for instance 14.4V → 20V or above) should be disabled before entering AM Mode. This will ensure that the supply voltage in AM Mode is limited to the battery voltage thereby minimizing the device power dissipation.

To avoid possible damage to the output stage, appropriate sequencing must be adhered to when activating or disabling AM Mode. The TAA4100 **MUST** be muted (MUTE_B = high) during logic changes of the AM pin.

To change from Class-T mode to AM Mode, the following procedure must be followed.

With AM = Low and MUTE_B = High → MUTE_B = Low → AM = High → MUTE_B = High

To change from AM Mode to Class-T mode, the following procedure must be followed.

With AM = High, MUTE_B = High → MUTE_B = Low → AM = Low → MUTE_B = High

Thus, MUTE_B is low during any transition of the AM pin.

PROTECTION CIRCUITS

The TAA4100 is guarded against over-current, over/under voltage, and over-temperature conditions. If the device goes into one of the various protection states, the FAULT pin goes to a logic HIGH state indicating a fault condition. When this occurs, all amplifier outputs are TRI-STATED and will float to VDD.

OVER-CURRENT PROTECTION

An over-current fault occurs if more than approximately 9.5 amps (typical) of current flows from any of the amplifier output pins. This can occur if the speaker wires are shorted together, if one side of the speaker is shorted to ground, or if an output is connected to VPP. An over-current fault sets an internal latch that automatically clears after a 600mS second delay.

OVER AND UNDER VOLTAGE PROTECTION

The over-voltage protection of the TAA4100 will be activated if the supply voltage is increased above 30.0 volts (typical) and 27.0 volts (minimum). This fault puts the amplifier into mute and resets automatically once the supply voltage is reduced below the hysteresis band (26.0 volts). The TAA4100 also has built-in load dump protection. This circuit puts the amplifier into sleep mode if the supply voltage is increased above 30V. The TAA4100 is able to survive power supply spikes to 60V if the duration is less than 50mS.

The TAA4100 is also equipped with under voltage protection. This circuit is activated if the supply voltage goes below 8.1 volts (typical) and causes the output to mute. Increasing the supply voltage above the hysteresis band (typically 9.5V) will bring the amplifier out of mute mode.

OVER-TEMPERATURE PROTECTION

An over-temperature FAULT occurs if the junction temperature of the part exceeds 160°C (typical). The thermal hysteresis is approximately 30°C, therefore the fault will automatically clear when the junction temperature drops below 130°C.

SLEEP PIN (Active LOW)

The SLEEPB ($\overline{\text{SLEEP}}$) pin is a logic input that when pulled low puts the TAA4100 into a low quiescent current mode. This pin must be pulled up to an external 3.3V or 5V supply to activate (disable sleep mode) the TAA4100. The sleep pin cannot be pulled up to VPP due to internal circuitry limitations. The amplifier takes approximately 500mS to come out of sleep. This period of time allows the input capacitor to charge fully assuming a value of 0.47uF. If the input capacitor size is increased, then additional time will be required to allow for the input capacitor to fully charge. To ensure that turn on is pop-free, the input capacitor must be fully charged before MUTE_B is pulled high.

MUTE_B PIN

The MUTE_B pin is a logic input that mutes the TAA4100. Pulling this pin low activates the mute circuitry. Pulling the pin high enables output switching and amplification. Please note that the input stage is still biased at approximately 2.5V, even when MUTE_B pin is low. This keeps the BIASCAP, C_B and input coupling capacitors, C_I, completely charged. This allows for a clean transition from mute to on, and vice-versa, which eliminates turn-on/off pops. Please note that DC calibration is done every time MUTE_B transitions from low to high. The DC calibration takes approximately 6mS.

FAULT PIN

The FAULT pin is a logic output that indicates various fault conditions within the device. These conditions include: over-voltage, under-voltage, over-current at any output, low charge pump voltage, low 5V regulator voltage, and over-temperature (junction temperature greater than approximately 160°C).

The FAULT pin is an open drain output. The recommended pull-up to an external 3.3V or 5V supply is 51kΩ. Alternatively, this pin can be pulled up to VPP through a 51kΩ resistor. A logic high on this pin indicates a fault condition. This pin has a 1mA maximum sink current capability.

HMUTE_B PIN

The HMUTE_B pin is a logic output that indicates if the TAA4100 is muted. This mute state can be simply caused a low state on the MUTE_B pin or by various fault conditions within the TAA4100. A logic low on the HMUTE_B pin indicates the TAA4100 is muted.

TURN-ON AND TURN-OFF NOISE

If turn-on or turn-off noise is present in a TAA4100 amplifier, the cause is frequently due to other circuitry external to the TAA4100. The TAA4100 has extremely sophisticated turn on and off pop suppression circuitry that will eliminate “pops” in nearly all configurations. It is recommended that the MUTE_B pin is pulled low during power-up and power-down of the VPP supply. In addition, MUTE_B must be held low until the input capacitor is fully charged. Thus, a power on sequence as follows is recommended. First, power up the TAA4100 with SLEEP_B and MUTE_B low. Pull SLEEP_B high and let input capacitor charge (minimum sleep time is about 500mS). Then, pull MUTE_B high. On power off, MUTE_B should be pulled low and then the power supply voltage removed. It is not necessary to activate SLEEP_B on power down.

OUTPUT FILTER DESIGN

One advantage of Tripath amplifiers over PWM solutions is the ability to use higher-cutoff-frequency filters. This means any load-dependent peaking/droop in the 20kHz audio band potentially caused by the filter can be made negligible. This is especially important for applications where the user may select a 4Ω or 8Ω speaker. Furthermore, speakers are not purely resistive loads and the impedance they present changes over frequency and from speaker model to speaker model.

The core material of the output filter inductor has an effect on the distortion levels produced by a TAA4100 amplifier. Tripath recommends an output inductor capable of at least 9A before saturation.

Recently, there have been a number of dual inductors designed specifically for bridged output switching amplifiers such as the TAA4100. These dual inductors are two inductors shielded by a common ferrite shield. They may be manufactured as common mode chokes with the windings wound in the same direction or as differential mode chokes with the windings wound in opposite directions. Since the ferrite reduces the energy storage capability of the inductor, it is important to ensure that the shielded dual inductor does not saturate at the maximum currents attainable by the TAA4100. Dual inductors wound as common mode inductors may aid in reducing common mode noise to the load. They also may result in lower than initial inductances due to electric field cancellation effects.

Tripath also recommends that an RC damper be used after the LC low-pass filter. No-load operation of a TAA4100 amplifier can create significant peaking in the LC filter, which produces strong resonant currents that can overheat the integrated MOSFETs and/or other components. The RC dampens the peaking and prevents problems.

It is highly recommended that the design process for a TAA4100 amplifier include an analysis of the interaction of intended speaker(s) with the LC filter and RC damper to ensure the desired frequency response is attained. Component values for the LC filter and RC damper may need to be altered from the Tripath suggestions to achieve the required response.

PARALLELING THE OUTPUTS

The outputs of the TAA4100 can be paralleled to increase the current capability as compared to a single output. Each output must still have its own inductor. Thus, the device output pins cannot be directly connected.

All 4 channels can be paralleled (after the inductors) or a pair of channels could be paralleled, for example CH1 and CH2 while using CH3 and CH4 a single bridged channels. To parallel, simply connect OUTxP to OUTyP of an adjacent channel, and OUTxN to OUTyN of an adjacent channel. Again, this connection needs to be after the output inductors (10uH in most cases).

Paralleling 2 channels will allow 2 ohm operation across the entire supply range of 10-26V. Paralleling all 4 channels will allow 1 ohm operation across the entire supply range. Please note that the same input signal must be driven into each channel that is being paralleled. Also, individual input capacitors should still be used for each channel.

PERFORMANCE MEASUREMENTS OF A TAA4100 AMPLIFIER

Tripath amplifiers operate by modulating the input signal with a high-frequency switching pattern. This signal is sent through a low-pass filter (external to the TAA4100) that demodulates it to recover an amplified version of the audio input. The frequency of the switching pattern is spread spectrum and typically varies between 200kHz and 1.5MHz, which is well above the 20Hz – 22kHz audio band. The pattern itself does not alter or distort the audio input signal but it does introduce some inaudible noise components.

The measurements of certain performance parameters, particularly those that have anything to do with noise, like THD+N, are significantly affected by the design of the low-pass filter used on the output of the

TAA4100 and also the bandwidth setting of the measurement instrument used. Unless the filter has a very sharp roll-off just past the audio band or the bandwidth of the measurement instrument ends there, some of the inaudible noise components introduced by the Tripath amplifier switching pattern will get integrated into the measurement, degrading it.

Tripath amplifiers do not require large multi-pole filters to achieve excellent performance in listening tests, usually a more critical factor than performance measurements. Though using a multi-pole filter may remove high-frequency noise and improve THD+N type measurements (when they are made with wide-bandwidth measuring equipment), these same filters can increase distortion due to inductor non-linearity. Multi-pole filters require relatively large inductors, and inductor non-linearity increases with inductor value.

Package Information

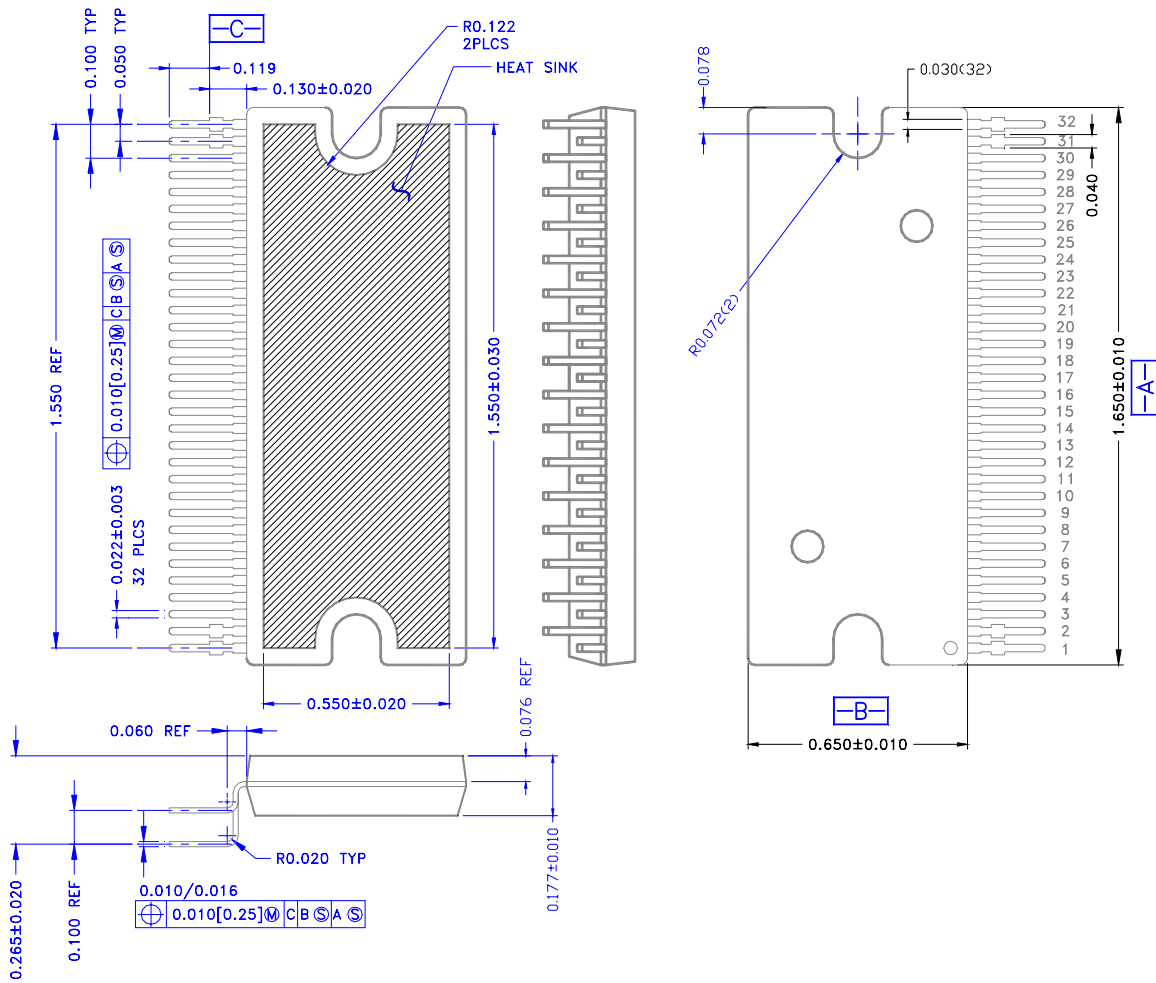

PRELIMINARY INFORMATION – This product is still in development. Specifications are subject to change based on future product analysis and characterization. Please contact Tripath Technology for additional information not included or covered in this advanced document.

Tripath Technology Inc. reserves the right to make changes without further notice to any products herein to improve reliability, function or design. Tripath does not assume any liability arising out of the application or use of any product or circuit described herein; neither does it convey any license under its patent rights, nor the rights of others.

Tripath and Digital Power Processing are trademarks of Tripath Technology Inc. Other trademarks referenced in this document are owned by their respective companies.

TRIPATH'S PRODUCTS ARE NOT AUTHORIZED FOR USE AS CRITICAL COMPONENTS IN LIFE SUPPORT DEVICES OR SYSTEMS WITHOUT THE EXPRESS WRITTEN CONSENT OF THE PRESIDENT OF TRIPATH TECHNOLOGY INC.

As used herein:

1. Life support devices or systems are devices or systems which, (a) are intended for surgical implant into the body, or (b) support or sustain life, and whose failure to perform, when properly used in accordance with instructions for use provided in this labeling, can be reasonably expected to result in significant injury to the user.
2. A critical component is any component of a life support device or system whose failure to perform can be reasonably expected to cause the failure of the life support device or system, or to affect its safety or effectiveness.

Contact Information

TRIPATH TECHNOLOGY, INC

2560 Orchard Parkway, San Jose, CA 95131

408.750.3000 - P

408.750.3001 - F

For more Sales Information, please visit us @ www.tripath.com/contact.htm

For more Technical Information, please visit us @ www.tripath.com/data.htm